

if not specified all tolerances \pm M_0

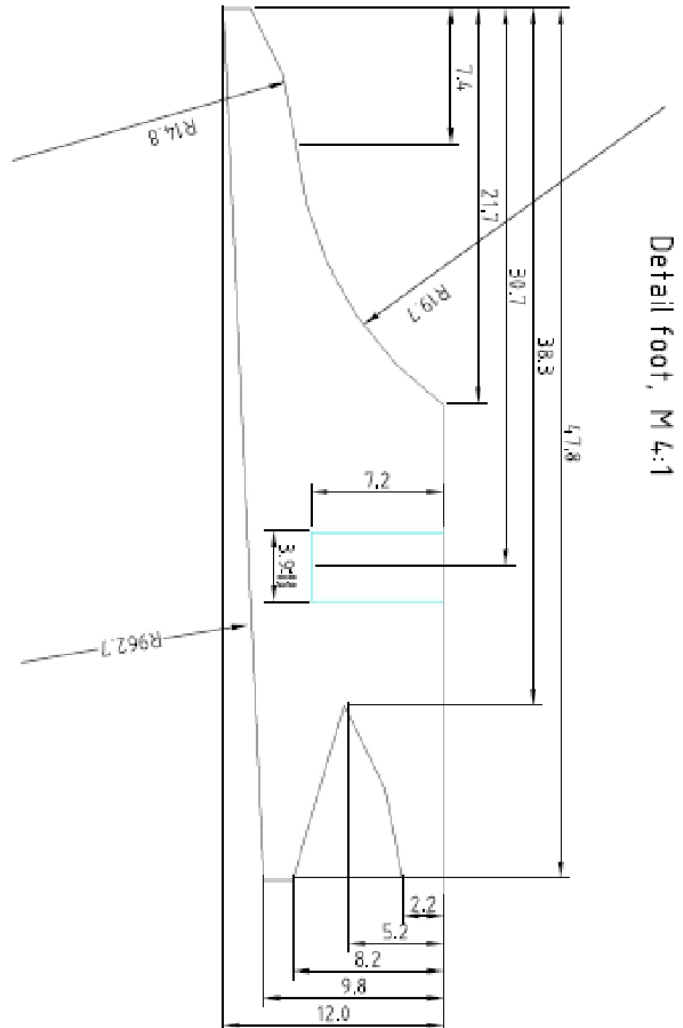
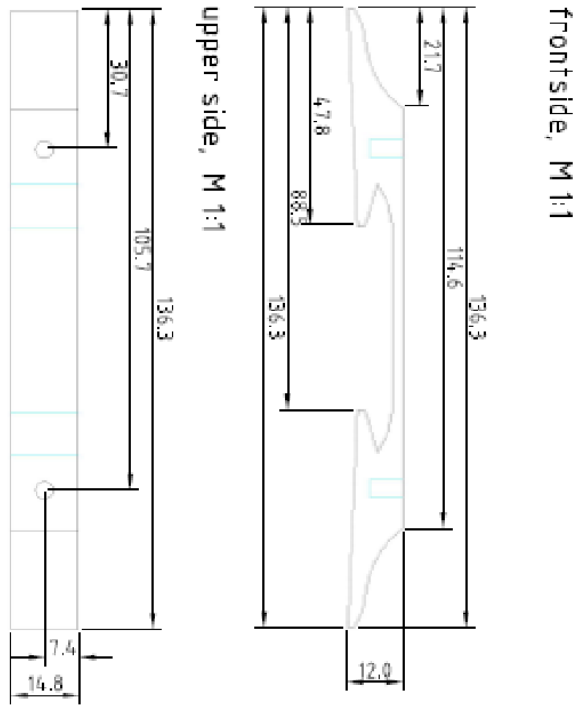

warwick®

Warwick Gmbh & Co Music Equipment KG
 Gewerbepark 46
 D-08258 Markneukirchen
 Tel : +49 (0) 37422 555 - 0
 Fax : +49 (0) 37422 555- 9999
 e-mail : info@warwick.de

Copyright
 This drawing is the property of Warwick Gmbh & Co Music Equipment KG.
 The information given on it is protected by copyright and any form of copying or reproduction is strictly forbidden.

FRV BRIDGE 00006
 foot
 EBONY

	NAME	DATE
DRAWN	Maxime Beau	Dienstag, 19. November 2019
CHK'D		A-01
Scale 1:1	SHEET 1 OF 5	A4

A

B

C

D

E

F

threath, M 2:1

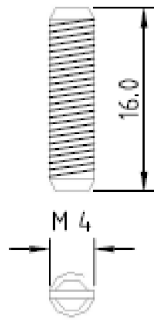

nut, M 2:1

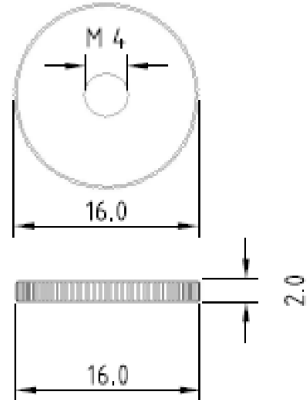

production:
chrome / gold



if not specified all tolerances $\pm \frac{1}{10}$



Warwick Gmbh & Co Music Equipment KG
 Gewerbepark 46
 D-08258 Markneukirchen
 Tel : +49 (0) 37422 555 - 0
 Fax : +49 (0) 37422 555- 9999
 e-mail : info@warwick.de

	NAME	DATE
DRAWN	Maxime Beau	Dienstag, 19. November 2019
CHK'D		A-01
	Scale 1:1	SHEET 2 OF 5
		A4

Bridge AZ10
 X62/100
 Threath , nut

Copyright
 This drawing is the property of Warwick Gmbh & Co Music Equipment KG.
 The information given on it is protected by copyright and any form of copying or reproduction is strictly forbidden.

frontside, M 1:1

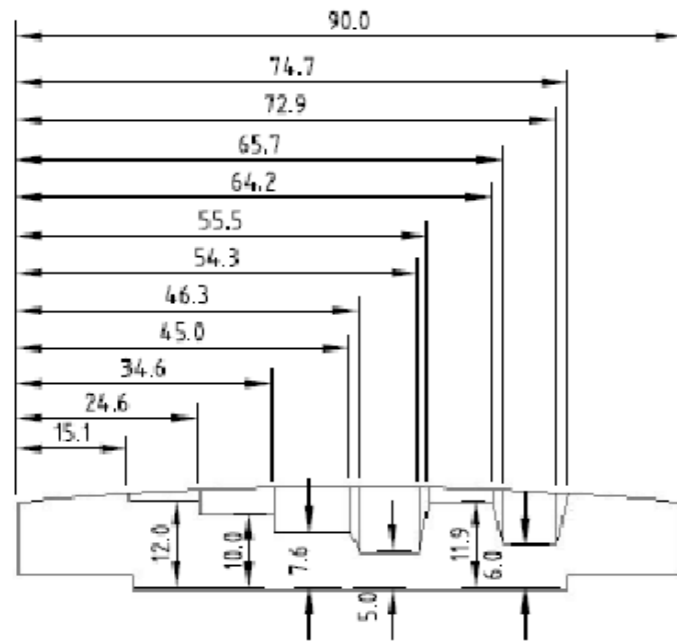

backside, M 2:1

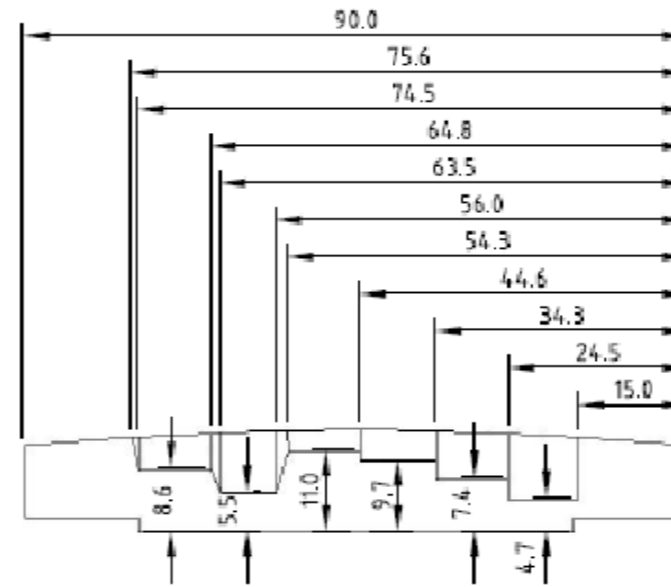

basic side, M 1:1

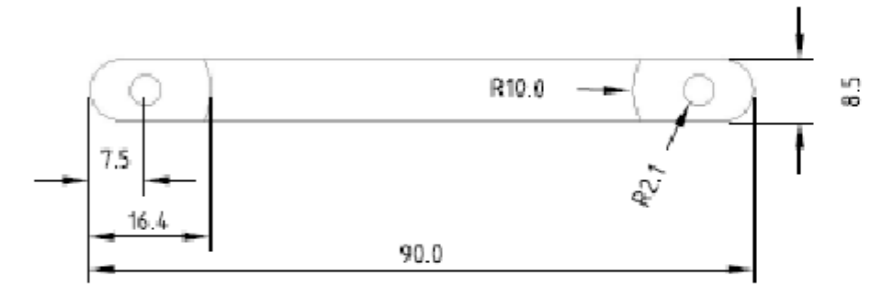

side, M 1:1

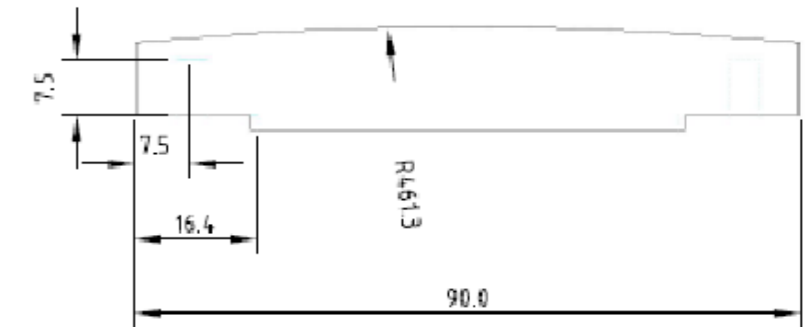

upper side, M 4:1

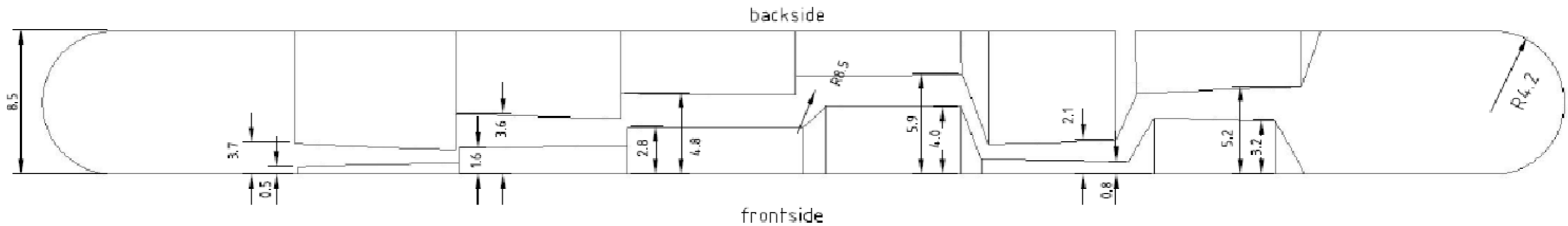

if not specified all tolerances $\pm \frac{1}{10}$

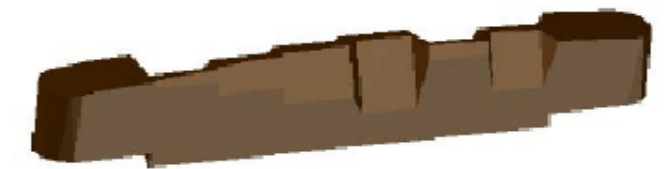

Warwick® Framus®

PROPRIETARY AND CONFIDENTIAL THE INFORMATION CONTAINED IN THIS DRAWING IS THE SOLE PROPERTY OF WARWICK GmbH Und Co Music Equipment KG. ANY REPRODUCTION IN PART OR AS A WHOLE WITHOUT THE WRITTEN PERMISSION OF WARWICK GmbH Und Co Music Equipment KG IS PROHIBITED.	EBONY	
	FRV BRIDGE 00006 TOP RIGHT HAND	
Warwick GmbH & Co Music Equipment KG represented by the managing director Hans Peter Wilfer Gewerbepark 46 D-08258 Markneukirchen GERMANY Phone: +49 (0) 37422 555 0 Fax: +49 (0) 37422 555 99 info@warwick.de	All units in mm unless otherwise specified	
	Maxime Beau	Scale 1:1
19.11.2019	Sheet 3 of 5	

frontside, M 1:1

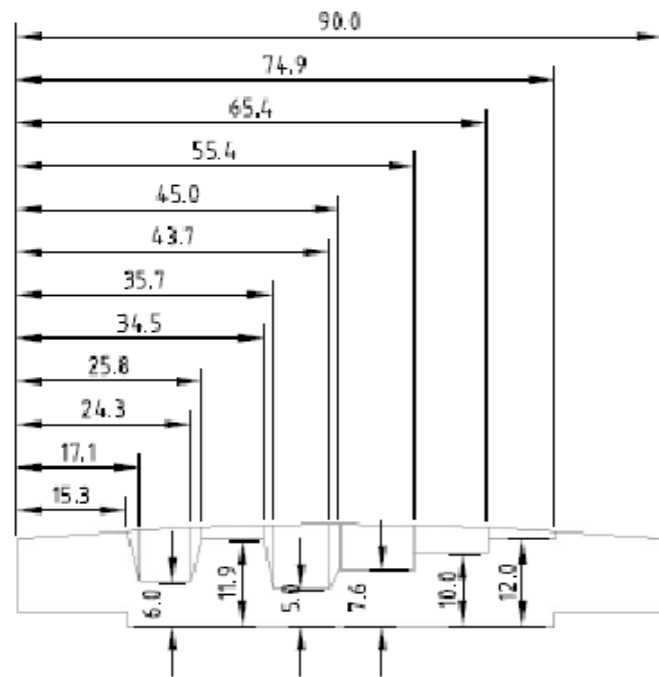

backside, M 2:1

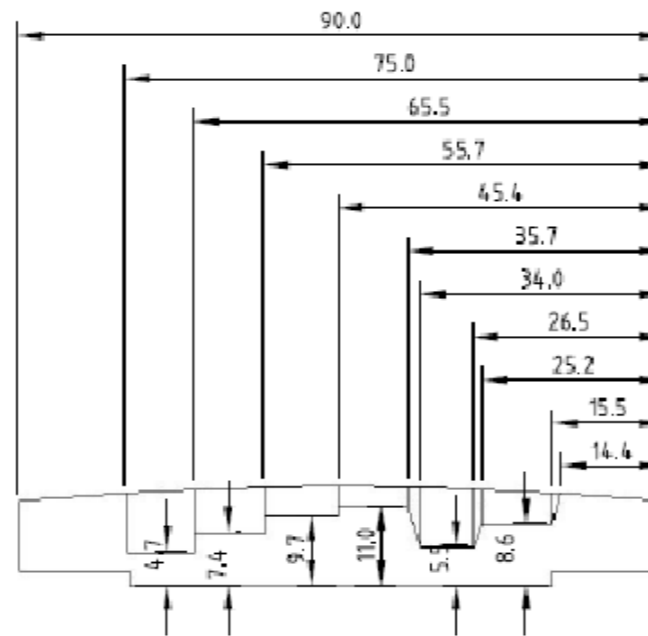

basic side, M 1:1

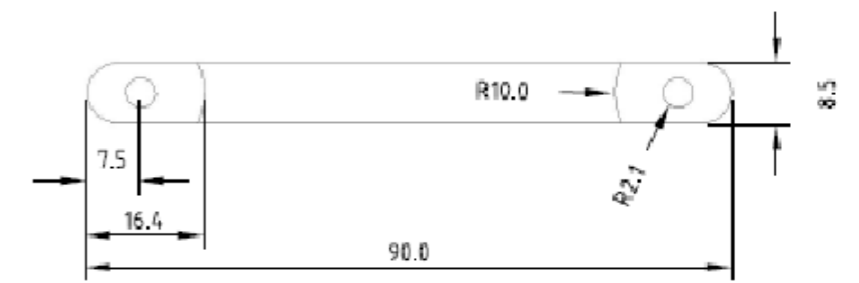

side, M 1:1

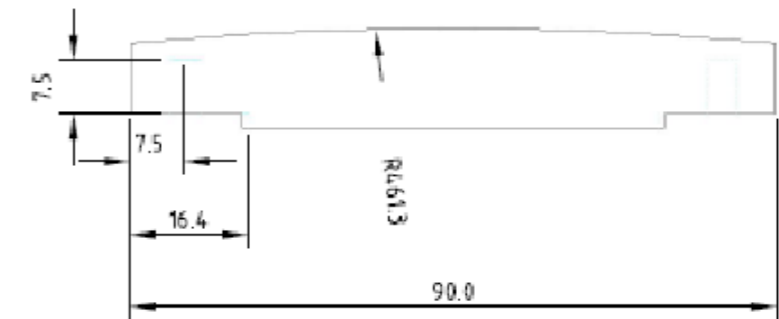

upper side, M 4:1

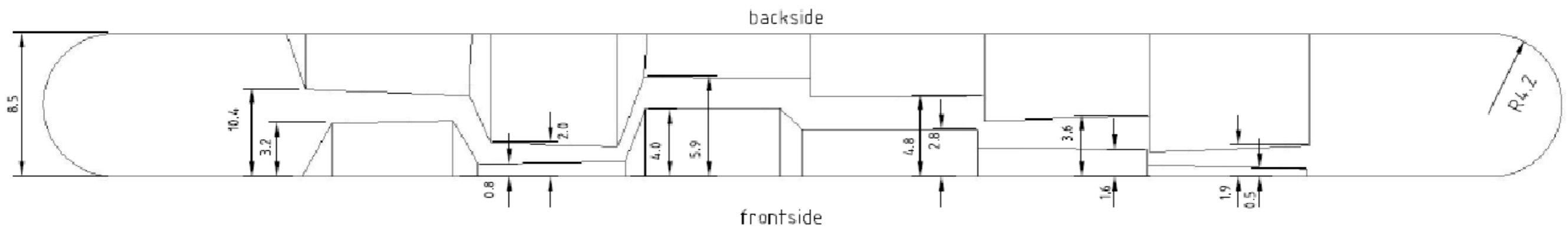

if not specified all tolerances $\pm \frac{1}{10}$



Warwick® Framus®

PROPRIETARY AND CONFIDENTIAL THE INFORMATION CONTAINED IN THIS DRAWING IS THE SOLE PROPERTY OF WARWICK GmbH Und Co Music Equipment KG. ANY REPRODUCTION IN PART OR AS A WHOLE WITHOUT THE WRITTEN PERMISSION OF WARWICK GmbH Und Co Music Equipment KG IS PROHIBITED.	EBONY	
	FRV BRIDGE 00006 TOP lefthand	
Warwick GmbH & Co Music Equipment KG represented by the managing director Hans Peter Wilfer Gewerbepark 46 D-08258 Markneukirchen GERMANY Phone: +49 (0) 37422 555 0 Fax: +49 (0) 37422 555 99 info@warwick.de	All units in mm unless otherwise specified	
	Maxime Beau	Scale 1:1
19.11.2019	Sheet 4 of 5	

A

B

C

D

E

F



warwick[®]

Warwick Gmbh & Co Music Equipment KG
 Gewerbepark 46
 D-08258 Markneukirchen
 Tel : +49 (0) 37422 555 - 0
 Fax : +49 (0) 37422 555- 9999
 e-mail : info@warwick.de

	NAME	DATE
DRAWN	Maxime Beau	Dienstag, 19. November 2019
CHK'D		A-01
	Scale 1:1	SHEET 5 OF 5

FRV BRIDGE 00006
 explosion overview

Copyright
 This drawing is the property of Warwick Gmbh & Co Music Equipment KG.
 The information given on it is protected by copyright and any form of copying or reproduction is strictly forbidden.