

Tuning Stability Starts Here



Thank you for choosing the *Hipshot® Tuner Upgrade Kit* for your guitar. The *Hipshot® Universal Mounting Plate™* system makes installation a breeze and keeps your guitar in original condition so its value doesn't diminish. Happy playing!



Hipshot.com

The only tool required is a 10 mm wrench.

10 mm

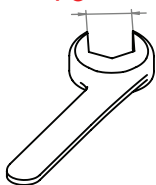

1 Remove your old tuners and bushings. Clean off your headstock with a soft cloth.

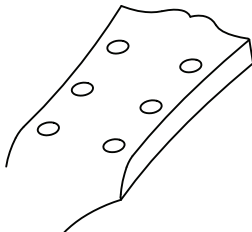

2 Identify and lay out the four plates.

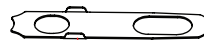

Small plates have 1 set of tabs.

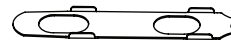

Large plates have 2 sets of tabs.



3 Arrange the Universal Mount Plates on your headstock with tabs facing up as shown.

Place small plates down first.

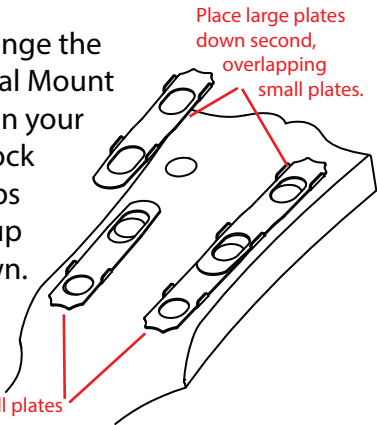

Place large plates down second, overlapping small plates.

4 Insert the tuner shafts through the plate and headstock holes. Loosely screw the reach nuts with washers from the front. *Don't tighten yet.*

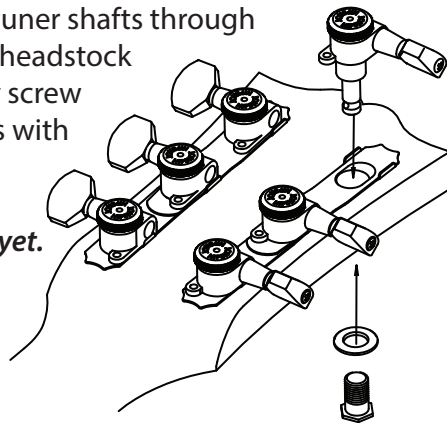

5 With the reach nuts still loose, adjust the final position of the tuners and plates. Make sure the tuners are resting between the tabs and that the plates are straight and attractively arranged. Now carefully tighten the reach nuts.

Don't over-tighten.

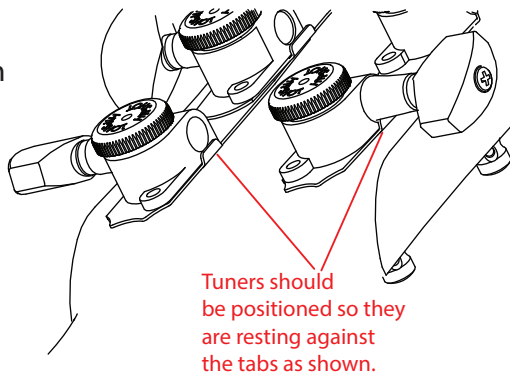

Tuners should be positioned so they are resting against the tabs as shown.