

A

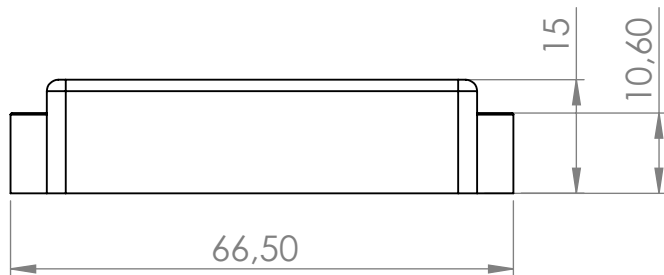

B

C

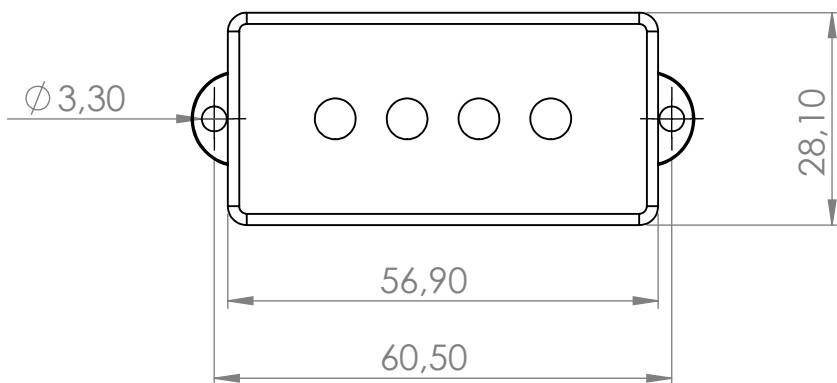

D

E

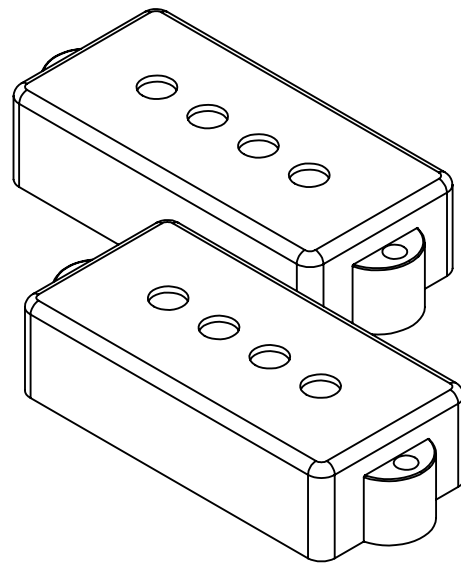

F



Warwick Gmbh & Co Music Equipment KG
 Gewerbepark 46
 D-08258 Markneukirchen
 Tel : +49 (0) 37422 555 - 0
 Fax : +49 (0) 37422 555- 9999
 e-mail : info@warwick.de

	NAME	DATE
DRAWN	Niedermaier	Freitag, 18. Dezember 2020
CHK'D		A-01
	Scale 1:1	SHEET 1 OF 1

SAC PU P4

Copyright
 This drawing is the property of Warwick Gmbh & Co Music Equipment KG.
 The information given on it is protected by copyright and any form of copying or reproduction is strictly forbidden.