

SP S 30178 B 5C 18
SP S 30178 B 5B 18
SP S 30178 B 5G 18

A

B

C

D

E

F

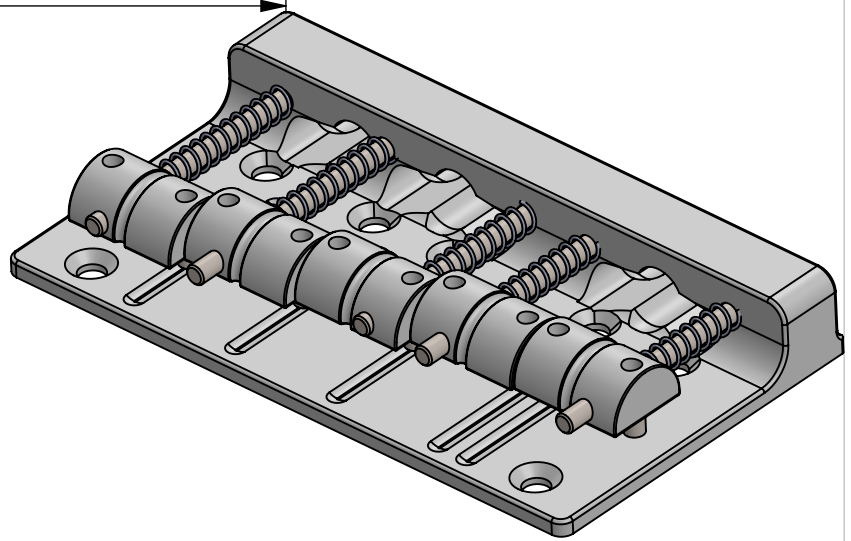
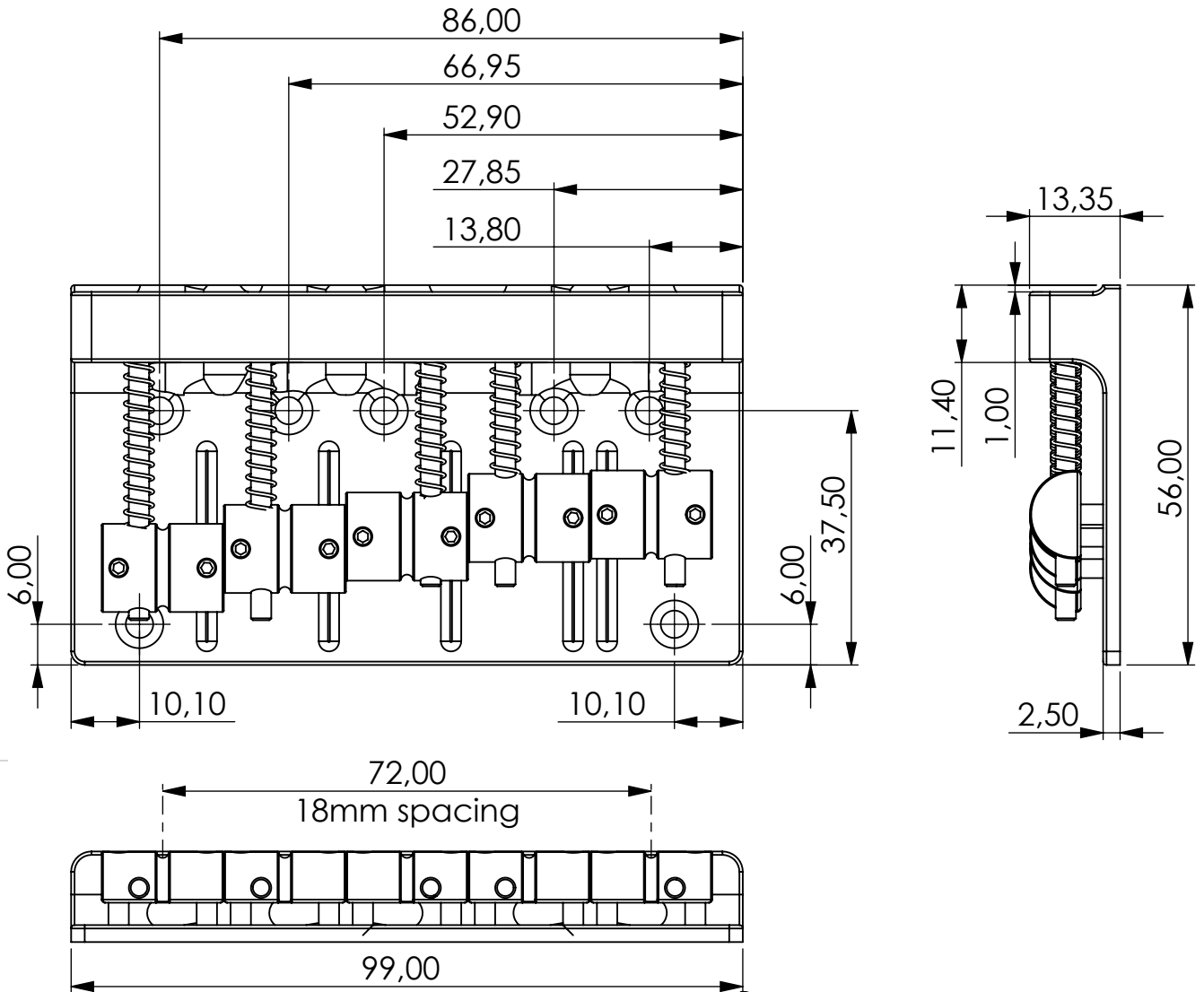

dimensions in mm

Sadowsky[®]

Warwick Gmbh & Co Music Equipment KG
 Gewerbepark 46
 D-08258 Markneukirchen
 Tel : +49 (0) 37422 555 - 0
 Fax : +49 (0) 37422 555- 9999
 e-mail : info@warwick.de

	NAME	DATE
DRAWN		Freitag, 31. März 2023
CHK'D		A-01
Scale 1:1	SHEET 3 OF 6	A4

SP S 30178

Copyright
 This drawing is the property of Warwick Gmbh & Co Music Equipment KG.
 The information given on it is protected by copyright and any form of copying or reproduction is strictly forbidden.